

VM-202

VM-202Kit & VM-202Kit-ACS

2-wire IP VIDEO INTERCOM KIT User Manual



Door station for
VM-202Kit-ACS

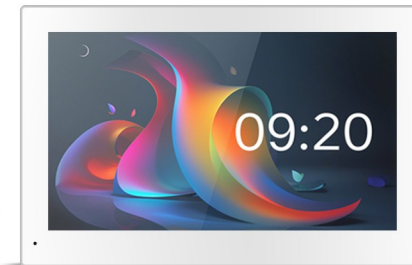

Monntor
VM-202M



Door station for
VM-202Kit

SAFETY INSTRUCTIONS



Warning

- ※ Read these instructions and keep them in a safe place for future reference.
- ※ Please refer all work related to the installation of this product to qualified service personnel or system technician.
- ※ Do not operate the appliance beyond its specified temperature, humidity or power source ratings.
- ※ Securely install the devices on vertical surfaces (solid walls/doors) not prone to vibration or impact.
- ※ Install the devices away from heat sources such as radiators, heat registers and stoves.
- ※ Handle the appliance with care. Do not strike or shake, as this may damage the device.
- ※ **The outdoor station, should be fitted with an approved weather shield if the chosen position is in direct sunlight, or in contact with rain, snow or irrigation sprinkler systems.**
- ※ Do not use strong or abrasive detergents when cleaning the appliance body. When the dirt is hard to remove, use a mild detergent and wipe gently.
- ※ Do not overload outlets and extension cords as this may result in a risk of fire or electric shock. Distributing, copying, disassembling, reverse compiling, reverse engineering, and also exporting in violation of export laws of the software provided with this product, is expressly prohibited.

Packing list

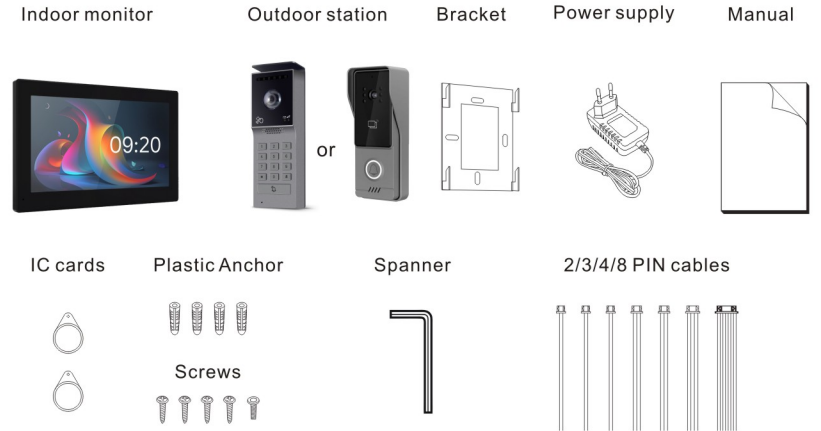

Function Description

Indoor monitor	
Screen	7" TFT LCD screen
Display Resolution	7"(1024*600)
Video decoding	H.264
Intercom Mode	Two-way intercom
Power Consumption	standby mode ≤ 2W, working mode ≤ 5.5W
Power supply	BUS power DC24(DC48V for optional)
Operating Temperature	0 ~ +50°C
Installation	Surface mount
Memory	Memory: itself can save 100 pictures (32K), TF card storage pictures/videos (15s), support for up to 512G TF memory cards
Motion Detection	Human detection
System Capacity	1 monitor to 6 monitors and 1-2 door stations.
Functions	Unlock/Monitor/Intercom/Remote control/Record
Advantages	Clock / Voice Message/Tuya Smart intercom
Weather	Network synchronization of weather information
Video surveillance IPC	via wired connection and Wi-Fi connection
Wiring	2*2Wire (S PoE)
Network connections	2.4G Wi-Fi

Outdoor station	
Camera	1/2.9 inch CMOS camera
Definition	1080P (1920*1080)
View angle	140° (Horizontal)
Leds for night	IR Leds
Day / Night	IR-Cut
Power consumption	Maximum 300mA
Power supply	Supplied from indoor monitor
Operating Temperature	-20°C ~ +60°C
Installation	Surface mount
Access control	IC card 13.56MHz / APP remote
Supported locks	Current lock, NO / NC lock
Outdoor station capacity	100 IC cards; password: 100 groups

Overview

Indoor monitor front panel

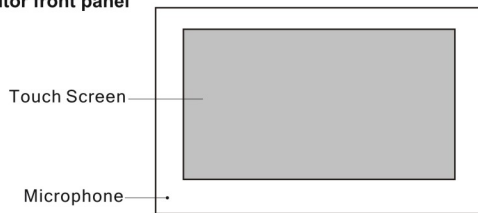

Indoor monitor rear panel

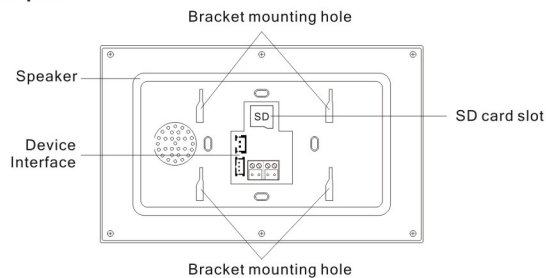

Outdoor station

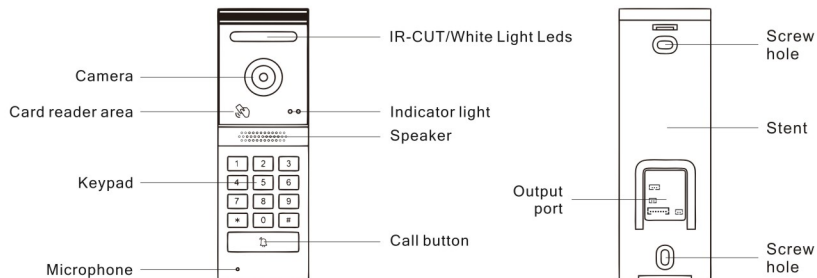

Installation

How to install the indoor monitor

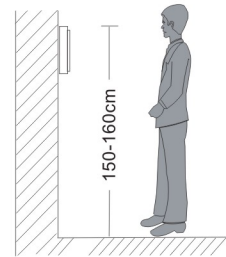

⚠ Note:

- * Please be far from the devices with intense radiation: TV, DVR, etc.
- * Do not disassemble privately to avoid the electric shock.
- * Do not drop, shake or knock the device, otherwise will damage the elements.
- * Choose the best position to install.
- * **Please turn off the power before installing.**

- * Keep at a distance of more than 30cm with AC power to avoid interference.
- * Keep away from the water, magnetic field and chemicals.

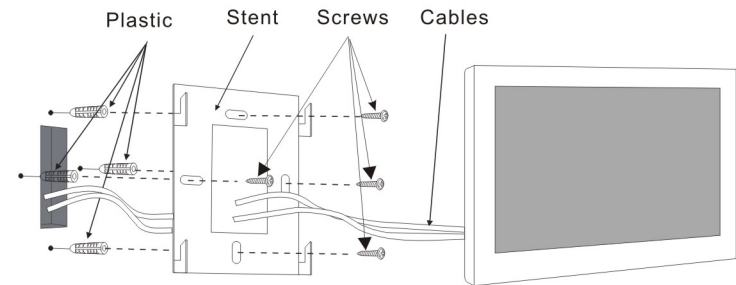

How to install the outdoor doorbell

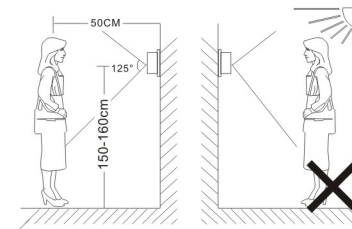

Do not expose the outdoor station to bright light or sun.

- * Do not install the outdoor station in the environment, e.g. direct sunlight, high temperature, high humidity, full of dust and corrosive chemicals.
- * Select the most suitable position where the camera is at user's eye level.

- * Avoid installing the device near intense radiation, e.g. AC motor and elevator.
- * Maintenance must be carried out by a qualified technician.
- * Avoid strong shocks and collisions, otherwise the exact internal components may be damaged.
- * Please turn off the power supply before installation.
- * Please maintain a distance of more than 30 cm from the AC power source to avoid external interference.
- * Keep it away from water and magnetic field.

Topology Diagram 2

1 outdoor station+ 4 indoor monitor

VM-DC 24V-2A
(Dc power supply)
Sold separately

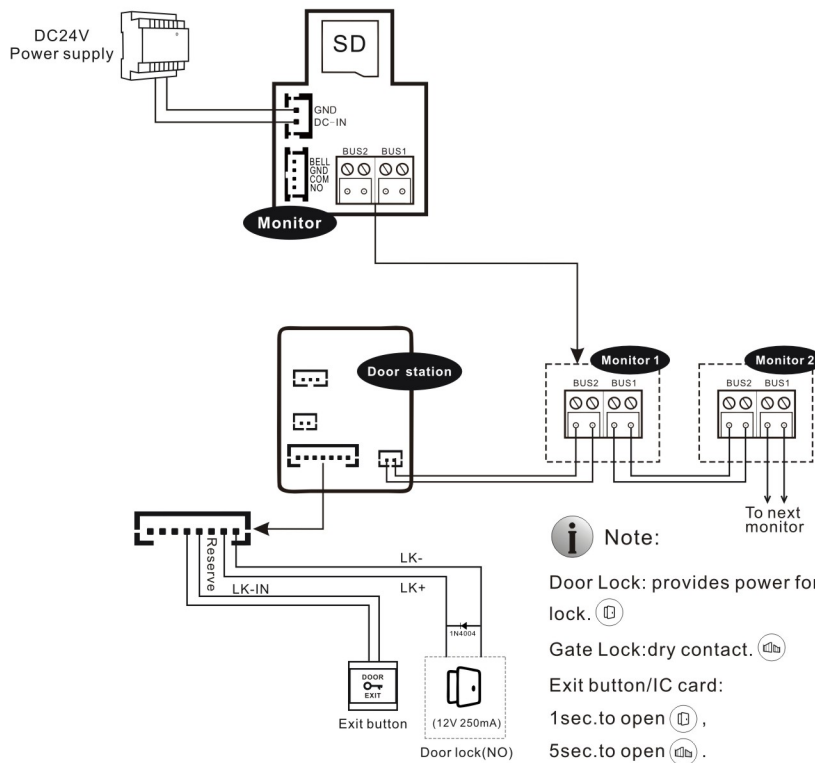
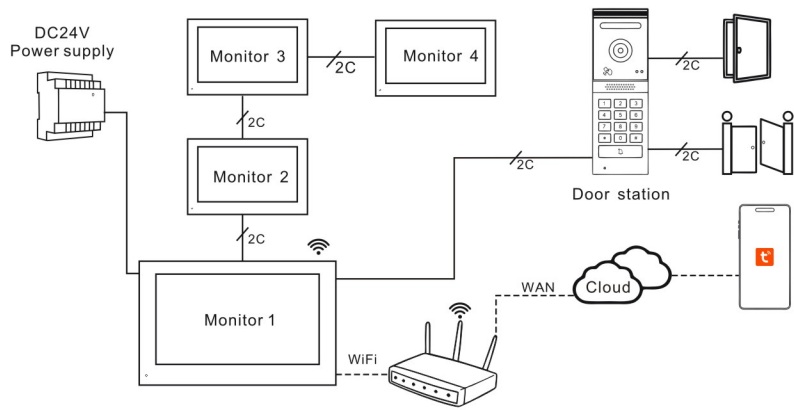

Topology Diagram 3

2 outdoor station+ 4 indoor monitor

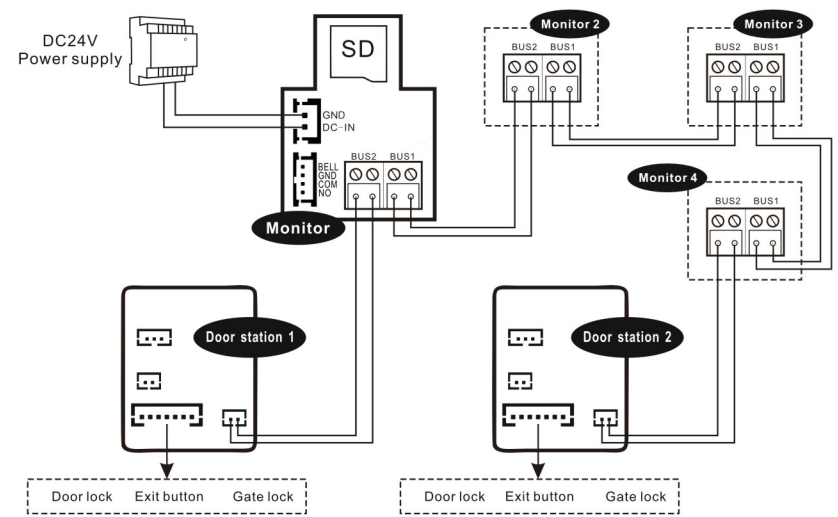
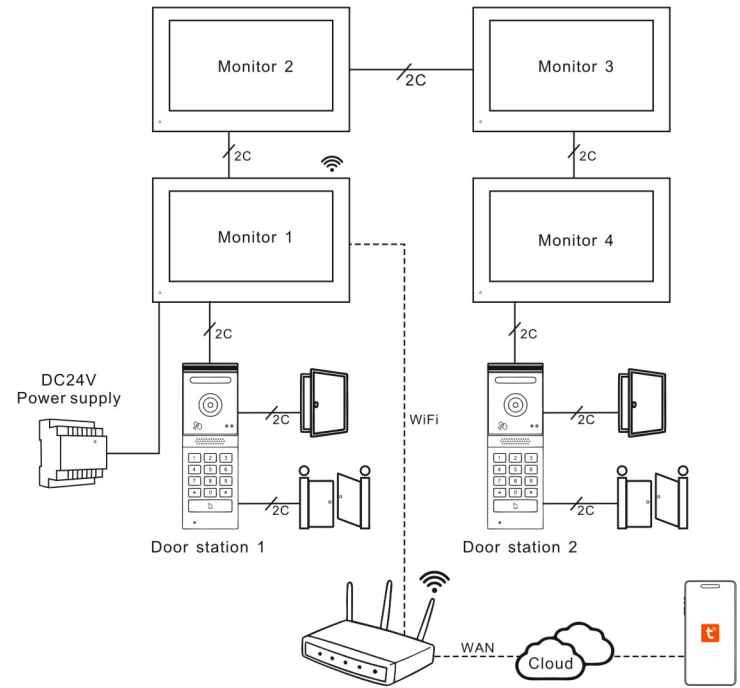

Topology Diagram 4

2 outdoor station+ 6 indoor monitor

VM-DC 48V
(48v power supply)
Sold separately

VM-202SW
(Switch)
Sold separately

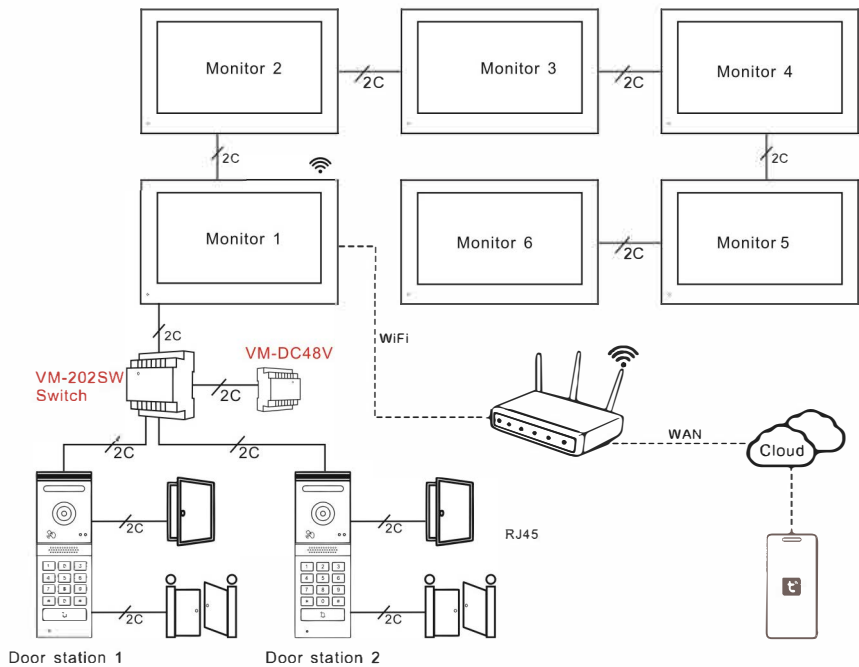

Visitor Call

Standby mode

The visitor press the **call** button on outdoor doorbell 1

A continuous ring tone is heard inside and outside

The visitor's image automatically displayed on the screen

Press the **Talk** button on the indoor monitor

▼ Stop ringing

Start conversation with the visitor

▼ The conversation duration is 120s at a time.

Press the **unlock** button on indoor monitor

Press the **unlock** button on indoor monitor

The visitor press the **call** button on outdoor doorbell 2

NOTICE

If both call buttons on two **outdoor stations** are pressed at approximate to the same time, the preference will be given to the **outdoor station** which call button was pressed first, unless the call button is pressed again after the indoor monitor go into standby mode, please be aware of that there is no indication on second **outdoor station**.

NOTICE

The indoor unit will automatically go into standby mode if you are not at home or have not reached the indoor unit in 60s.

Release the door lock connected to the Lock+ /Lock- ports.

Press the **hang up** button on indoor monitor

End

Release the door lock connected to the NO/NC ports.

- When the option on the menu "Basic -> Record Mode" is set to "Video", in calling mode the whole process will be recorded; When the option on the menu "Basic -> Record Mode" is set to "Picture", in calling mode the first picture will be captured.
- In monitoring mode, touch the icon "📹" to start manual record, and press this button again to stop manual record. All video recording files are stored in the TF card. In monitoring mode, touch the icon "📷" to capture a frame of the video stream as a still photo by manual. Photos are stored in the TF card first, if the monitor doesn't detect the TF card, photos will be stored in the built-in memory of the monitor.

Password unlocking

Please input [password #] on outdoor station, password length 4-8 digits.

Swipe card unlocking(exit button the same)

Support cell phone NFC unlocking.

Swipe the registered user card---wait 1sec---Di sound to open the **Door lock** of outdoor station. Swipe the registered user card---wait 3sec---Du sound to open the **Gate lock** of outdoor station.

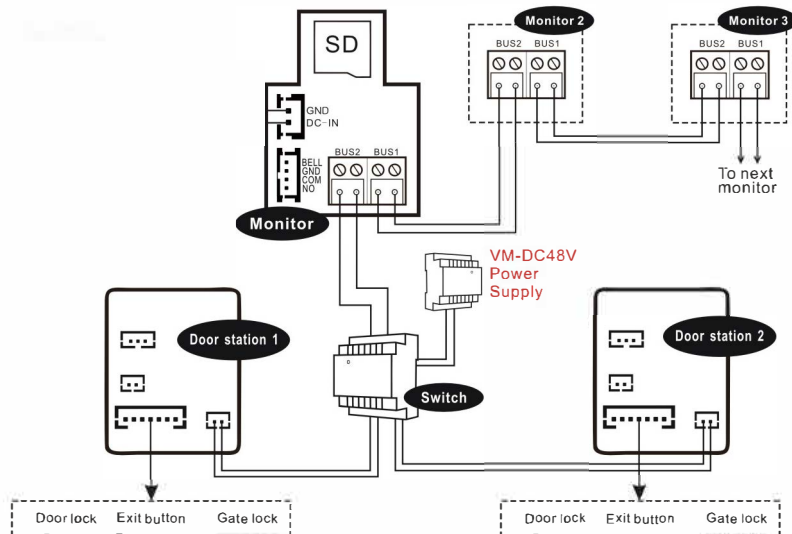

Monitoring

Standby mode

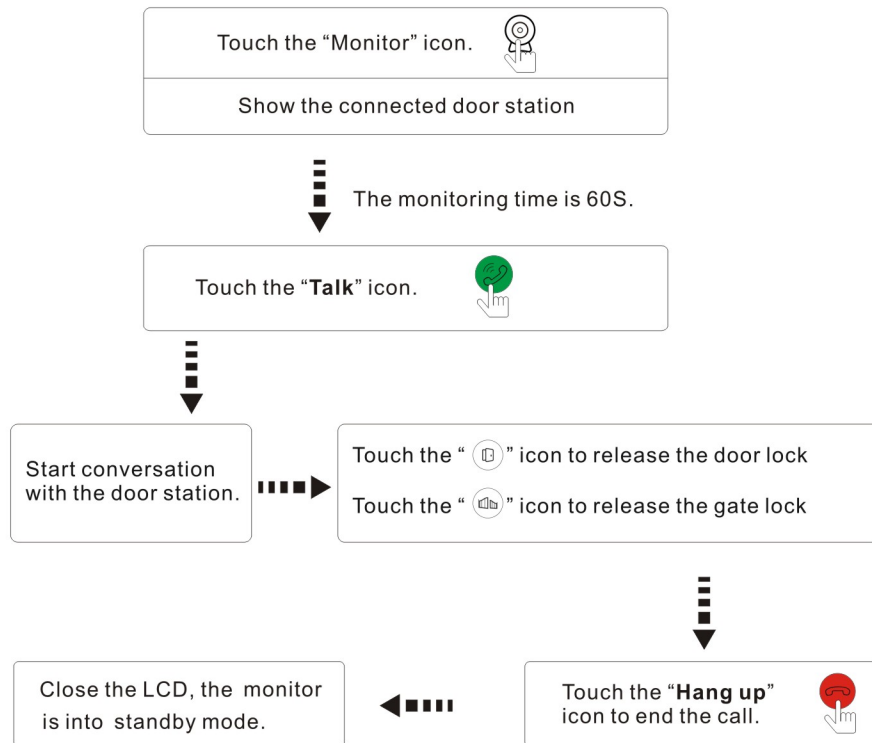

i NOTE:

- 1.If use 2 or more indoor monitors, the system will automatically recognize the master and extensions, the same image will be shown on different slave extensions.
- 2.When visitor press door station call button, system will turn off monitoring mode and switch to show door station calling image.
- 3.When in record mode, press " Video " or " Photo " button to start video or photo recording, press record button again to stop recording.
- 4.If the recording mode is set to "Video", a SD card needs to be inserted.

Monitor Introductions

Launch

When starting the monitor for the first time, a language selection interface will appear. Select the local language.

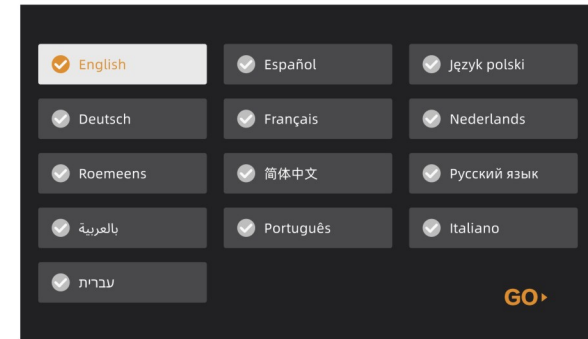

There are 3 device types, Villa, Building and Guard Unit. Choose the correct type according to your usage environment.

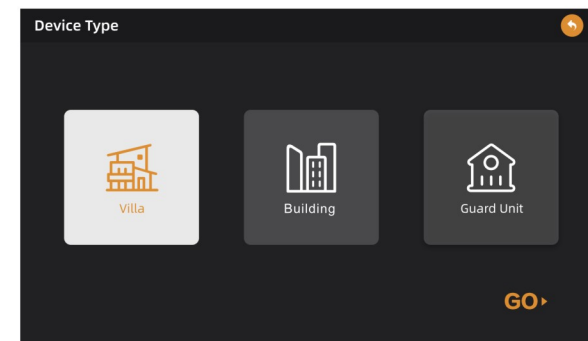

Customize system function items, which can enable or disable the functions you need.

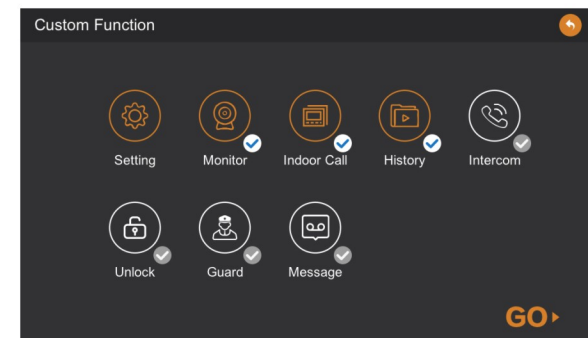

Standby mode

Display day/month/year/week/hour/minute/second and the weather informations. Clock/date display on standby mode within 60 second, after disappear enter black screen mode to protect LCD.

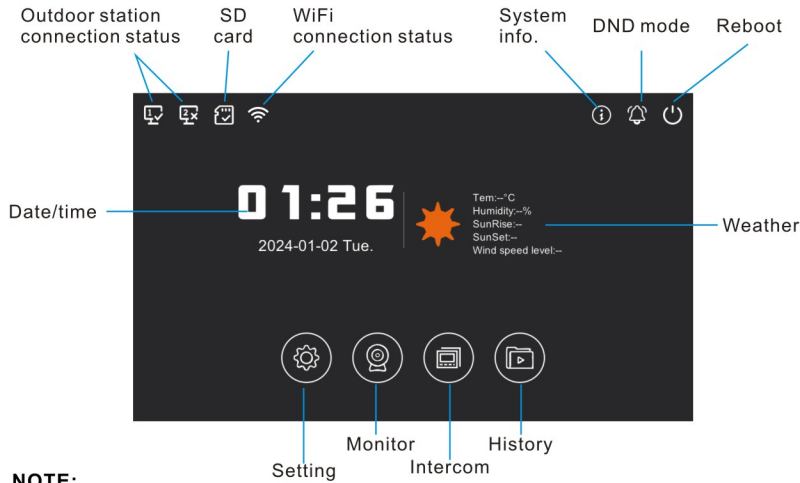

NOTE:

When the monitor is connected to WiFi and the app is successfully added, the date, time, weather information will be synchronized by locally.

Indoor call

This function is for communication between indoor monitors. A monitor communicates with one monitor in the same time.

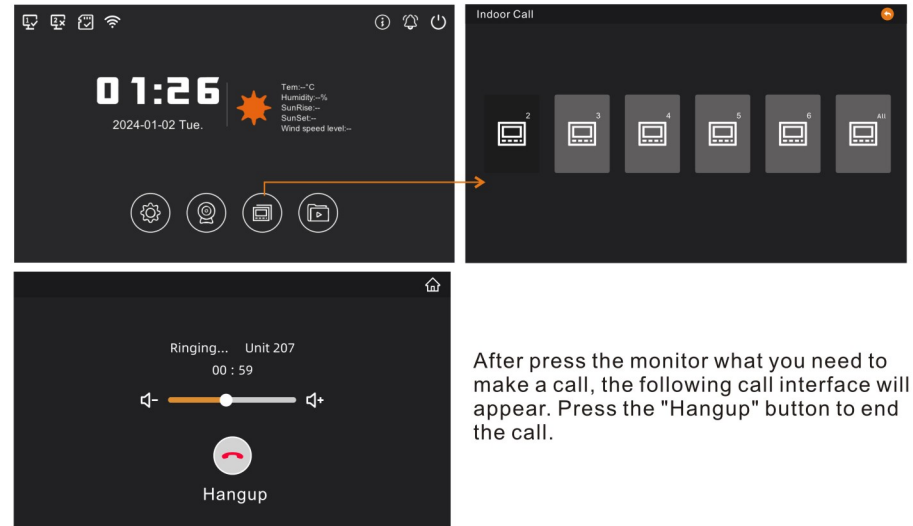

After press the monitor what you need to make a call, the following call interface will appear. Press the "Hangup" button to end the call.

Call and monitoring

Select 1 device for monitoring ↗

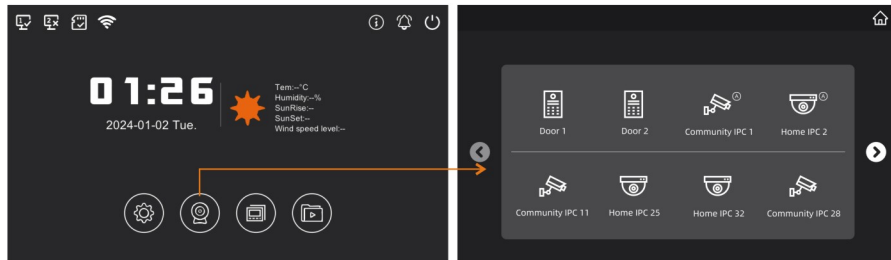

Outdoor Calling and monitoring ↗

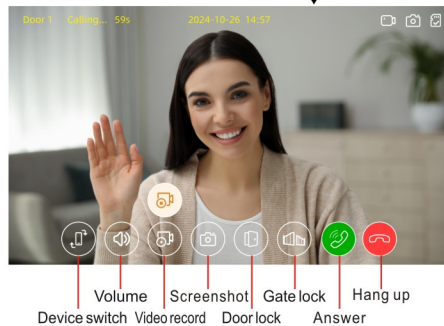

History

In this menu, you can view recorded files, including answered, unanswered, human detection and alarm record. The recorded files include images and videos. The image files are in JPG format and the video files are in Mp4 format.



Video playback ↗

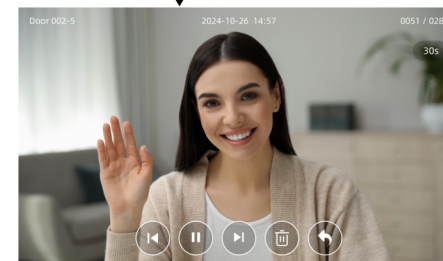

Picture playback ↗

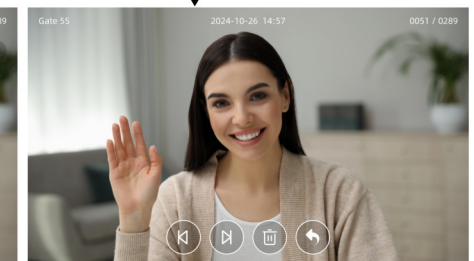

Menu settings

Basic

In this menu you can change language, auto recording, choose picture or video recording. When the auto record function is turned on, when a visitor rings the doorbell, it will automatically record or take a screenshot. Otherwise, manual recording is required.

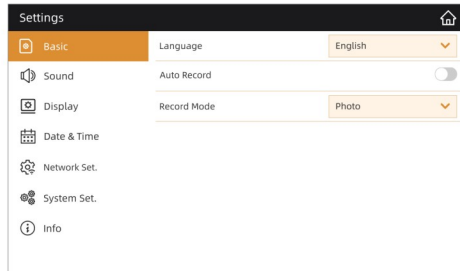

Sound

In this menu you can turn on or off screen touch tone, set ring time as 10s/20s/30s/60s, select ring mode as Standard or Customization, Ring and Call volume settings.

Note: Customized ringtones: insert SD card - add a new folder: music - put customized ringtones in the folder [unlimited].

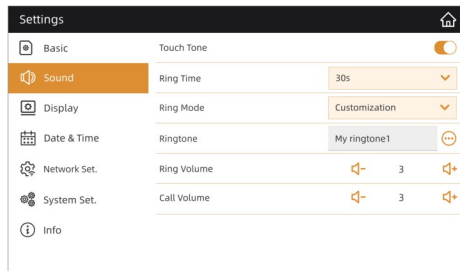

Display

In this menu you can set the screen display brightness, standby mode and screen clean functions.

Standby mode: Date & Time, Black Screen and Digital Frame. Start time: 30/60/90/120 seconds
End time: 1 / 3 / 5 minutes.

(Digital photo frame supports customized screensaver pictures: insert SD card - add a new folder: picture - folder to store the picture files need to be rotated: 1024*600px. jpg [can be up to 50 pcs].)

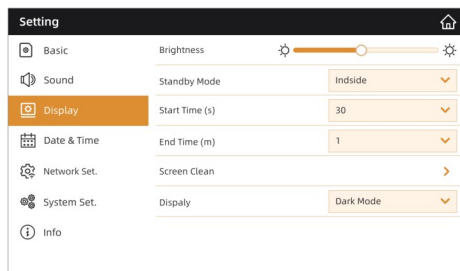

15

Date & Time

When the monitor is connected to internet and the app is successfully added, the date and time information will be synchronized by locally. And the Time is displayed in 24-hour format only.

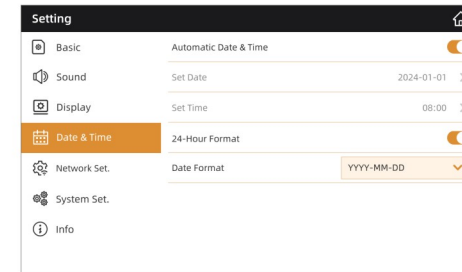

Network Set.

Wireless or Wired connection network

Wired connection mode: (it works when connect a switch.) The local network connection can be automatically or manually configured with an IP address.

Wi-Fi connection mode: (show as below) To select a correct Wi-Fi in the list and input password to connect.

Click the connected WI-FI name to configure if can assign IP address automatically, this function is enabled by default. If assign IP address automatically failed, please manually configure the IP address, subnet mask and default gateway.

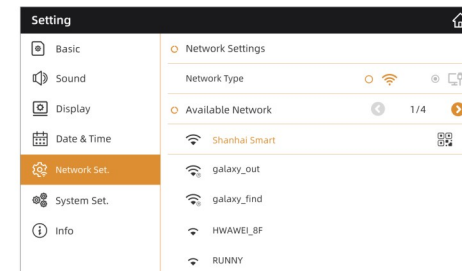

Note:
(only supports 2.4G WiFi, 5G WiFi is not supported)

Before connecting to the network, please download Smart Life or Tuya Smart application from APP store or Google Play store. When network connect successfully, click on the right side of the connected WIFI, will open the QR code interface. Scan the left QR code to download the APP.

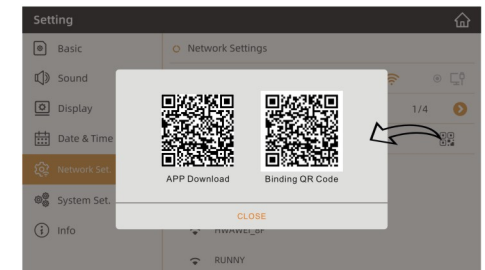
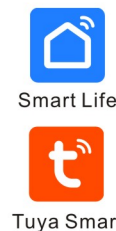

16

Note:

- 1). Router Band--This IP indoor monitor will only connect to the 2.4GHZ band. If you have a dual-band router, you must create unique SSID for the 2.4GHZ and 5GHZ bands. Prior to initiating the syncing process, make sure your device is connect to the 2.4GHZ SSID.
- 2). Router b/g/n --This IP indoor monitor works on 802(b/g/n) network.
- 3). Bring the monitor and the WIFI router within 49 feet(about 15 meters).
- 4). Please check if the WiFi router has the DHCP function enabled.
- 5). Check if the WiFi password is correct, no special characters,numbers and letters are recommended.
- 6). Make sure the WiFi router connected to the Internet.

Add device to APP

Step 1. After the monitor is successfully connected to WiFi.

Step 2. Connect your smart phone to the WiFi router which you want the monitor to be connected to.

Step 3. Login the Smart Life or Tuya Smart APP add device.

Method 1

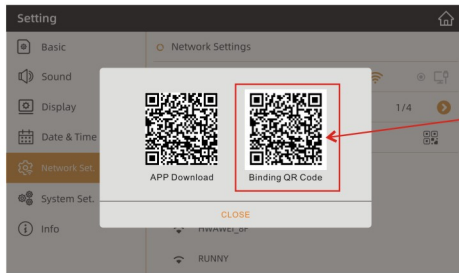

Use APP Scan the QR code on the right side to bind the device. The app will automatically complete the binding process.

Method 2

- Click "Add Device" or "+";
- The APP will automatically search for devices;
- Select the device found in the search list and click "Add";
- The device will automatically add;
- Click the "Done" button to complete the device addition.

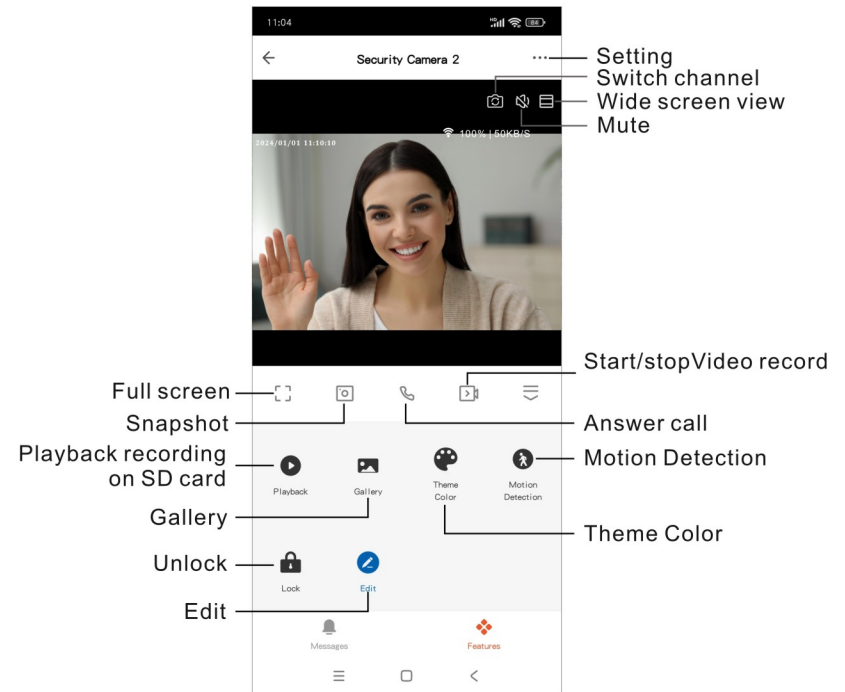
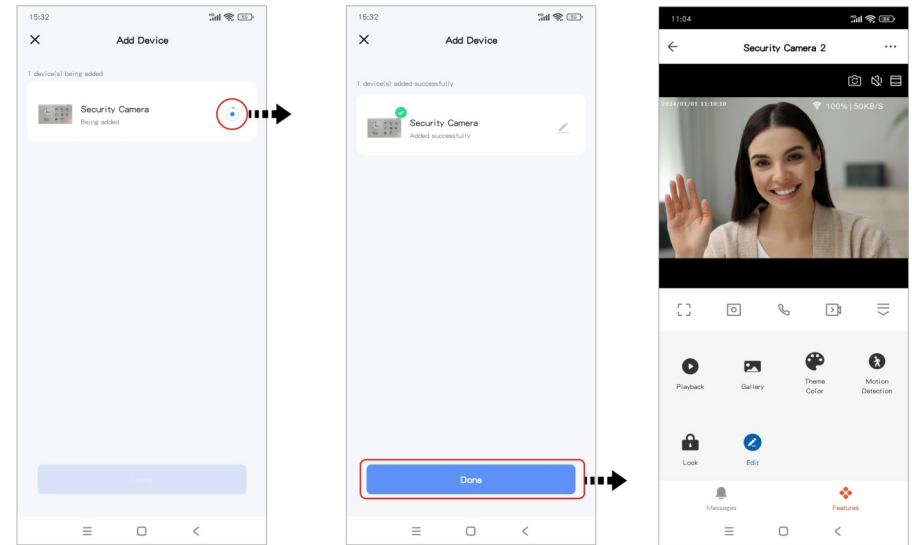
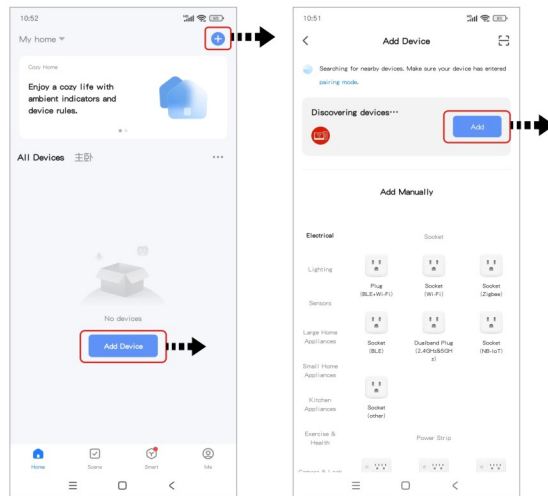

- Setting
- Switch channel
- Wide screen view
- Mute
- Start/stopVideo record
- Answer call
- Motion Detection
- Theme Color
- Full screen
- Snapshot
- Playback recording on SD card
- Gallery
- Unlock
- Edit

Share device via Home Management

Support up to 10 mobile phones to connect online at the same time.

Note: The shared accounts are allowed to have unlock functions.

Step 1: Create a home (Setting a Home Name)

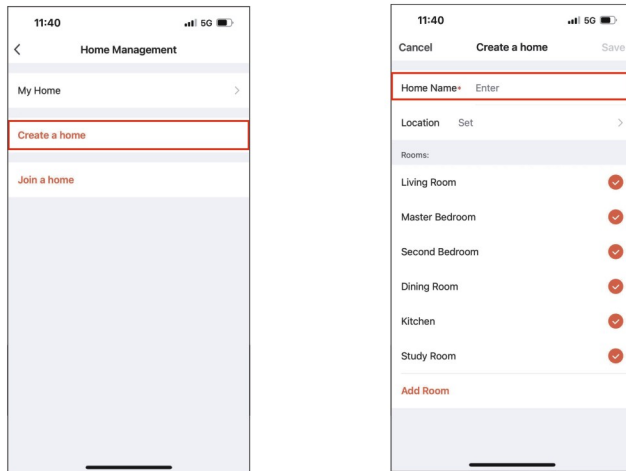

Step 2: Add member(Enter member's TUYA account)

Step 3: Choose the home and Add Device.

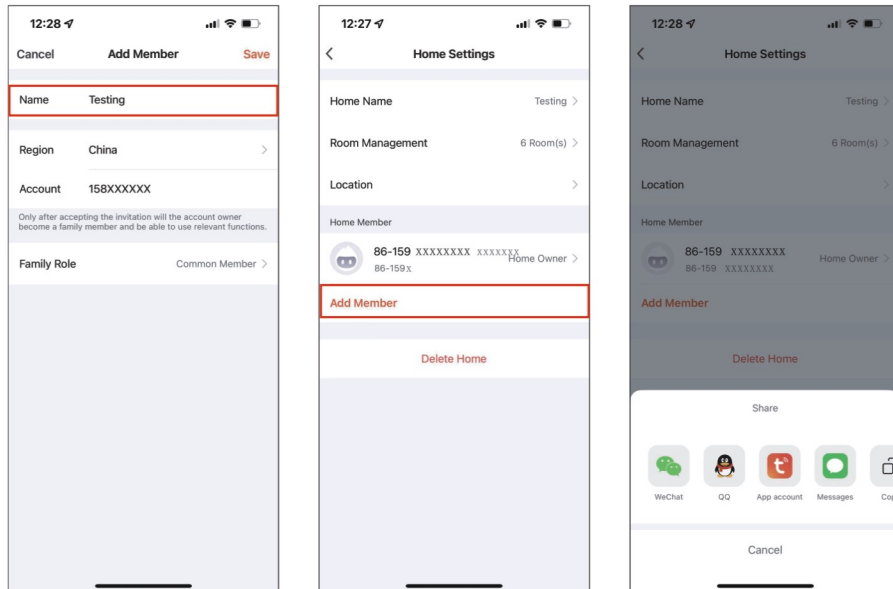

On new member's account, select the suitable home to operate the device

System Set.

This menu include User Settings and Engineer Settings. Need to enter the administrator password when entering.

User Settings default password is: **123456**

Engineer Settings default password is : **230901**

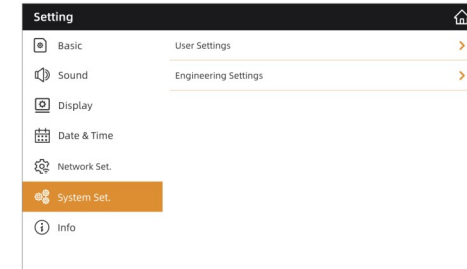

User Settings

Access control

In this menu, you can management operations on card,password.

Also you can format SD card, system upgrade,system reset and modify administrator password etc.

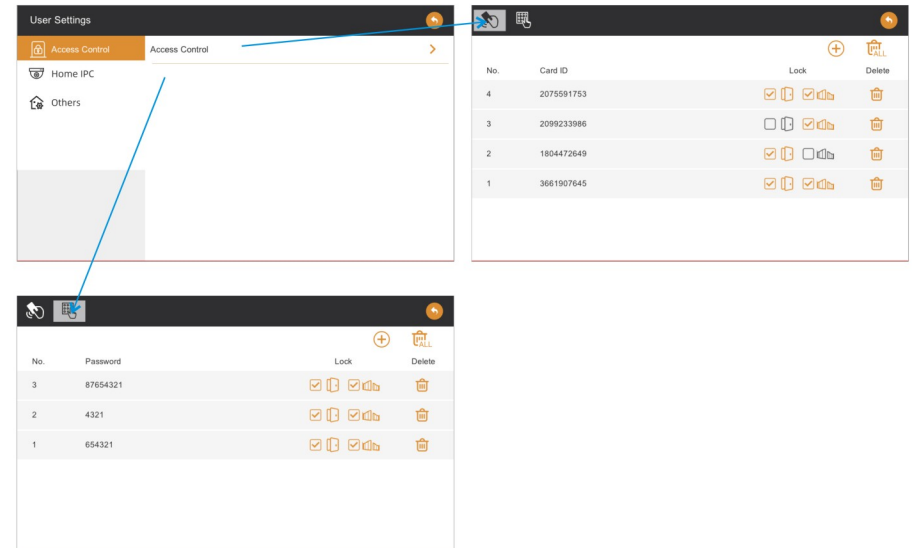

Note:

Before operating on card,password,please ensure that your outdoor station has the corresponding function,otherwise it cannot be operated.

VM-202Kit-ACS has card and password function. VM-202Kit has only card function.

Password: supports virtual password unlocking (anti-peep mode). eg. xx+password or password+xx

Others

Leave Message

Open the voice message setting interface, click icon to enable the function. Please make sure insert SD card.

Click to record the voice, click again to end it, and click to play the voice. Then click [Confirm] to save the voice message settings.

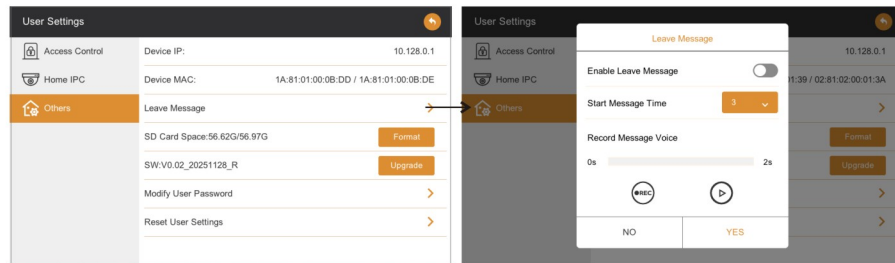

Note:

Please insert SD card. Once trigger this function, when outdoor station calling, indoor monitor will play voice message and start video recording, and save in history logs.

Formatting the SD card

Click [Format] and [Confirm] to format the SD card.

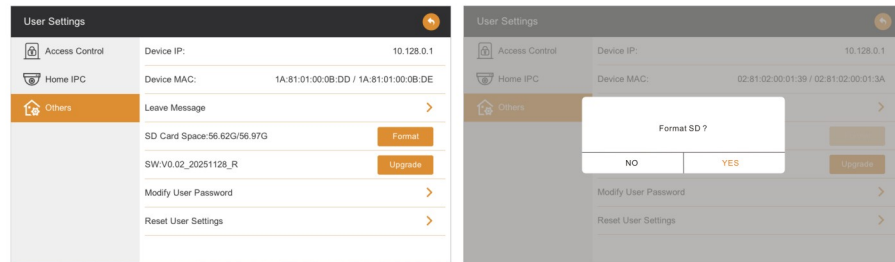

To upgrade firmware for indoor monitor

Open the SD card file selection screen. Select the upgrade package and click [Confirm] to upgrade.

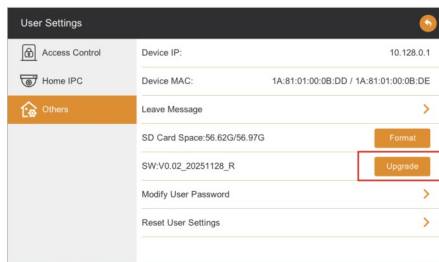

Note:

If the software version of the device is newest or same as the software version in the SD card, the upgrade will not be entered.

Engineer Settings

In this menu you can set Unit No., Access control, Human Detection, Door settings, Camera settings and other advanced settings.

Unit No.

If there are multiple monitors in one system, the Unit No. will be automatically recognized and assigned.

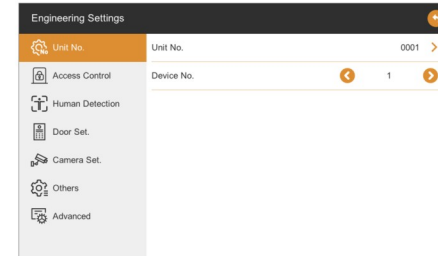

Access Control

To manage cards/passwords/fingerprints, extend to different buildings in a large community.

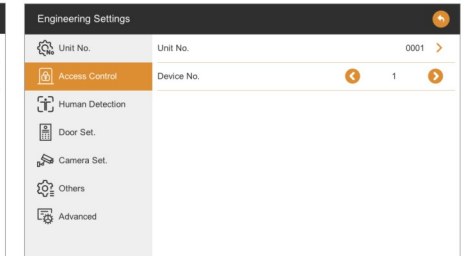

Human Detection

It only triggers human body movements and can greatly improve the accuracy of alerts.

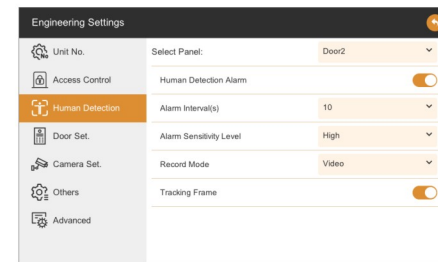

Door Set.

To set address and parameters of outdoor station. (Door unlock delay 1sec. and Gate unlock delay 3sec.default.) It including firmware upgrade also for outdoor station.

